

LME49713

High Performance, High Fidelity Current Feedback Audio Operational Amplifier

General Description

The LME49713 is an ultra-low distortion, low noise, ultra high slew rate current feedback operational amplifier optimized and fully specified for high performance, high fidelity applications. Combining advanced leading-edge process technology with state-of-the-art circuit design, the LME49713 current feedback operational amplifier delivers superior signal amplification for outstanding performance. Operating on a wide supply range of $\pm 5V$ to $\pm 18V$, the LME49713 combines extremely low voltage noise density ($1.9nV/\sqrt{Hz}$) with very low THD+N (0.00008%) to easily satisfy the most demanding applications. To ensure that the most challenging loads are driven without compromise, the LME49713 has a high slew rate of $\pm 1900V/\mu s$ and an output current capability of $\pm 100mA$. Further, dynamic range is maximized by an output stage that drives 150Ω loads to within 2.9V of either power supply voltage.

The LME49713's outstanding CMRR (88dB), PSRR (102dB), and V_{OS} (0.05mV) give the amplifier excellent operational amplifier DC performance.

The LME49713 is available in an 8-lead narrow body SOIC and 8-lead metal can (TO-99). Demonstration boards are available.

Key Specifications

■ Power Supply Voltage Range	$\pm 5V$ to $\pm 18V$
■ THD+N ($A_V = 1$, $R_L = 100\Omega$, $V_{OUT} = 3V_{RMS}$, $f = 1kHz$)	0.0006% (typ)
■ THD+N ($A_V = 1$, $R_L = 600\Omega$, $V_{OUT} = 1.4V_{RMS}$, $f = 1kHz$)	0.00008% (typ)

■ Input Noise Density	$1.9nV/\sqrt{Hz}$ (typ)
■ Slew Rate	$\pm 1900V/\mu s$ (typ)
■ Bandwidth ($A_V = -1$, $R_L = 2k\Omega$, $R_F = 1.2k\Omega$)	132MHz (typ)
■ Input Bias Current	1.8 μA (typ)
■ Input Offset Voltage	0.05mV (typ)

Features

- Easily drives 150Ω loads
- Optimized for superior audio signal fidelity
- Output short circuit protection
- 102dB (typ) PSRR and 88dB (typ) CMRR
- SOIC High Performance and Metal can packages

Applications

- Ultra high quality audio amplification
- High fidelity preamplifiers
- High fidelity multimedia
- State of the art phono pre amps
- High performance professional audio
- High fidelity equalization and crossover networks
- High performance line drivers
- High performance line receivers
- High fidelity active filters

Connection Diagrams

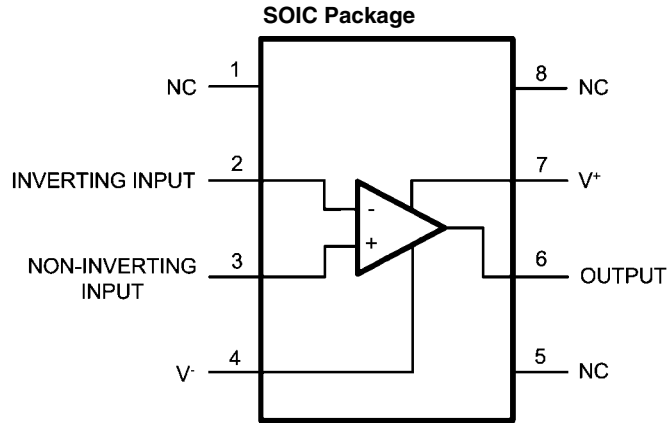

20213201

**Order Number LME49713MA
See NS Package Number M08A**

LME49713MA Top Mark

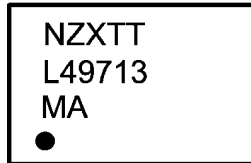

20213202

- N = National Logo**
- Z = Assembly plant code**
- X = 1 Digit date code**
- TT = Die traceability**
- L49713 = LME49713**
- MA = Package code**

Metal Can

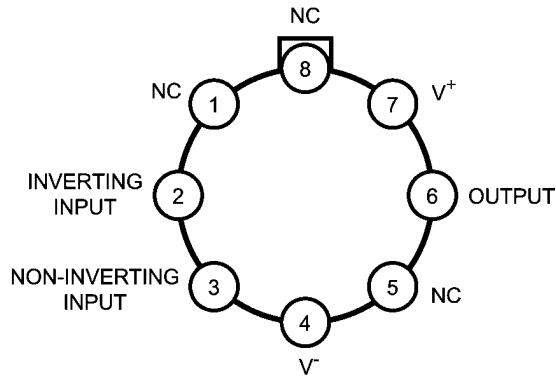

20213222

**Order Number LME49713HA
See NS Package Number H08C**

Absolute Maximum Ratings (Notes 1, 2)

If Military/Aerospace specified devices are required, please contact the National Semiconductor Sales Office/ Distributors for availability and specifications.

Power Supply Voltage ($V_S = V^+ - V^-$)	38V
Storage Temperature	-65°C to 150°C
Input Voltage	(V-) - 0.7V to (V+) + 0.7V
Output Short Circuit (Note 3)	Continuous

Power Dissipation	Internally Limited
ESD Rating (Note 4)	2000V
ESD Rating (Note 5)	200V
Junction Temperature	150°C
Thermal Resistance	
θ_{JA} (MA)	145°C/W
Temperature Range	
$T_{MIN} \leq T_A \leq T_{MAX}$	-40°C $\leq T_A \leq$ 85°C
Supply Voltage Range	$\pm 5.0V \leq V_S \leq \pm 18V$

Electrical Characteristics (Notes 1, 2) The following specifications apply for the $V_S = \pm 15V$, $R_L = 2k\Omega$, $R_{SOURCE} = 10\Omega$, $f_{IN} = 1kHz$, and $T_A = 25^\circ C$, unless otherwise specified.

Symbol	Parameter	Conditions	LME49713		Units (Limits)
			Typical	Limit	
			(Note 6)	(Note 7)	
THD+N	Total Harmonic Distortion + Noise	$A_V = 1$, $V_{OUT} = 3V_{RMS}$, $R_F = 1.2k\Omega$	0.0006	0.00065	% (max)
		$R_L = 100\Omega$, $V_{OUT} = 3V_{RMS}$ $R_L = 600\Omega$, $V_{OUT} = 1.4V_{RMS}$	0.00008	0.0004	% (max)
IMD	Intermodulation Distortion	$A_V = 1$, $V_{IN} = 3V_{RMS}$ Two-tone, 60Hz & 7kHz 4:1	0.00009		%
BW	Bandwidth	$A_V = -1$, $R_F = 1.2k\Omega$	132		MHz
SR	Slew Rate	$V_O = 20V_{P-P}$, $A_V = -1$	± 1900		V/ μs
FPBW	Full Power Bandwidth	$V_{OUT} = 20V_{P-P}$, $A_V = -1$	30		MHz
t_s	Settling time	$A_V = -1$, 10V step, 0.1% error range	50		ns
e_n	Equivalent Input Noise Voltage	$f_{BW} = 20Hz$ to 20kHz	0.26	0.6	μV_{RMS} (max)
	Equivalent Input Noise Density	$f = 1kHz$ $f = 10Hz$	1.9 11.5	4.0	nV/ \sqrt{Hz} (max)
i_n	Current Noise Density	$f = 1kHz$ $f = 10Hz$	16 160		pA/ \sqrt{Hz}
V_{OS}	Input Offset Voltage		± 0.05	± 1.0	mV (max)
$\Delta V_{OS}/\Delta Temp$	Average Input Offset Voltage Drift vs Temperature	-40°C $\leq T_A \leq$ 85°C	0.29		$\mu V/^\circ C$
PSRR	Average Input Offset Voltage Shift vs Power Supply Voltage	$V_{SUPPLY} = \pm 5V$ to $\pm 15V$ (Note 8)	102	100	dB (min)
I_B	Input Bias Current	$V_{CM} = 0V$	1.8	6	μA (max)
$\Delta I_{OS}/\Delta Temp$	Input Bias Current Drift vs Temperature	-40°C $\leq T_A \leq$ 85°C			
		Inverting input Non-inverting input	4.5 4.7		nA/ $^\circ C$ nA/ $^\circ C$
I_{OS}	Input Offset Current	$V_{CM} = 0V$	1.3	5	μA (max)
V_{IN-CM}	Common-Mode Input Voltage Range		± 13.5	(V+) - 2.0 (V-) + 2.0	V (min) V (min)
CMRR	Common-Mode Rejection	-10V < V_{cm} < 10V	88	87	dB (min)
Z_{IN}	Non-inverting-input Input Impedance	-10V < V_{cm} < 10V	1.2		M Ω
	Inverting-input Input Impedance	-10V < V_{cm} < 10V	58		Ω
Z_T	Transimpedance	$V_{OUT} = \pm 10V$			
		$R_L = 200\Omega$	4.2	2.0	M Ω (min)
		$R_L = \infty$	4.7	2.65	M Ω (min)
V_{OUTMAX}	Maximum Output Voltage Swing	$R_L = 150\Omega$	± 12.1	± 11.3	V (min)
		$R_L = 600\Omega$	± 12.6	± 12.4	V (min)

Symbol	Parameter	Conditions	LME49713		Units (Limits)
			Typical	Limit	
			(Note 6)	(Note 7)	
I_{OUT}	Output Current	$R_L = 150\Omega, V_S = \pm 18V$	± 100	± 93	mA (min)
I_{OUT-CC}	Instantaneous Short Circuit Current		± 140		mA
R_{OUT}	Output Resistance	$f_{IN} = 5MHz$ Closed-Loop Open-Loop	TBD 10		Ω Ω
I_S	Total Quiescent Current	$I_{OUT} = 0mA$	8	9.5	mA (max)

Note 1: "Absolute Maximum Ratings" indicate limits beyond which damage to the device may occur, including inoperability and degradation of device reliability and/or performance. Functional operation of the device and/or non-degradation at the *Absolute Maximum Ratings* or other conditions beyond those indicated in the *Recommended Operating Conditions* is not implied. The *Recommended Operating Conditions* indicate conditions at which the device is functional and the device should not be operated beyond such conditions. All voltages are measured with respect to the ground pin, unless otherwise specified.

Note 2: The *Electrical Characteristics* tables list guaranteed specifications under the listed *Recommended Operating Conditions* except as otherwise modified or specified by the *Electrical Characteristics Conditions* and/or Notes. Typical specifications are estimations only and are not guaranteed.

Note 3: Amplifier output connected to GND, any number of amplifiers within a package.

Note 4: Human body model, applicable std. JESD22-A114C.

Note 5: Machine model, applicable std. JESD22-A115-A.

Note 6: Typical values represent most likely parametric norms at $T_A = +25^\circ C$, and at the *Recommended Operation Conditions* at the time of product characterization and are not guaranteed.

Note 7: Datasheet min/max specification limits are guaranteed by test or statistical analysis.

Note 8: PSRR is measured as follows: V_{OS} is measured at two supply voltages, $\pm 5V$ and $\pm 15V$. $PSRR = |20\log(\Delta V_{OS}/\Delta V_S)|$.

Typical Performance Characteristics

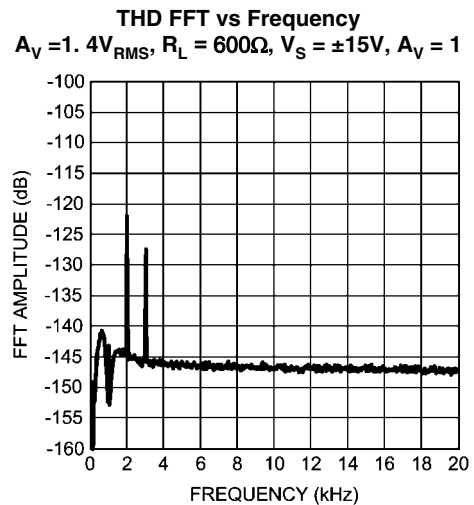
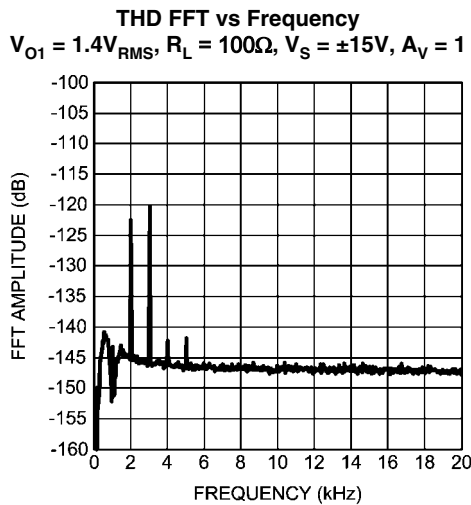
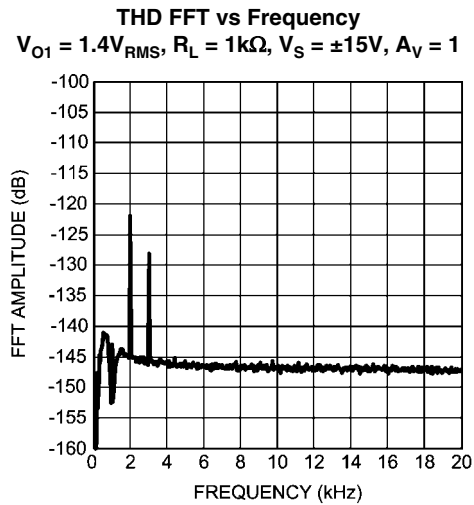
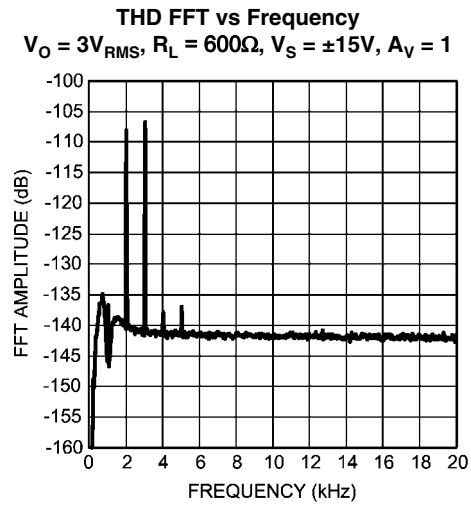
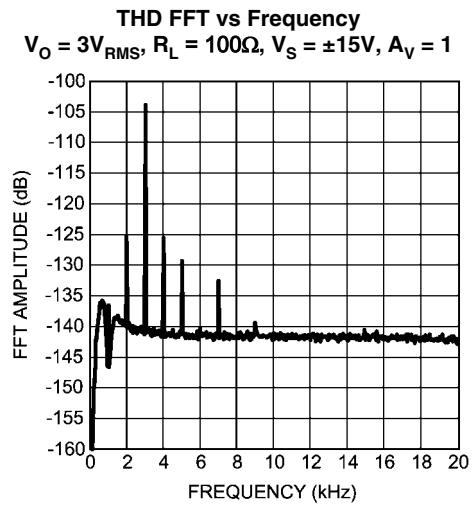
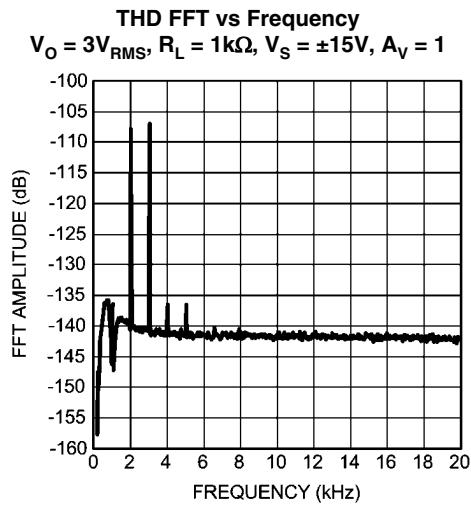

THD vs Frequency
 $V_O = 3V_{RMS}, R_L = 100\Omega, SOIC$

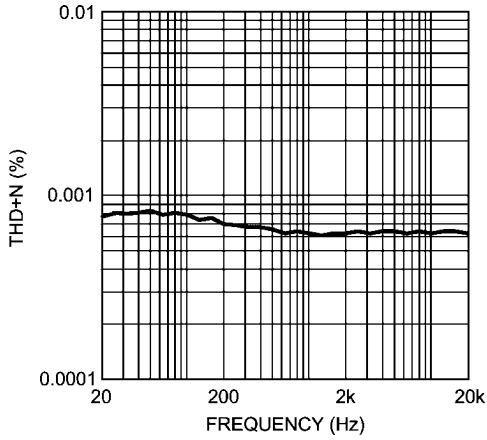

202132p5

THD vs Frequency
 $V_O = 3V_{RMS}, R_L = 600\Omega, SOIC$

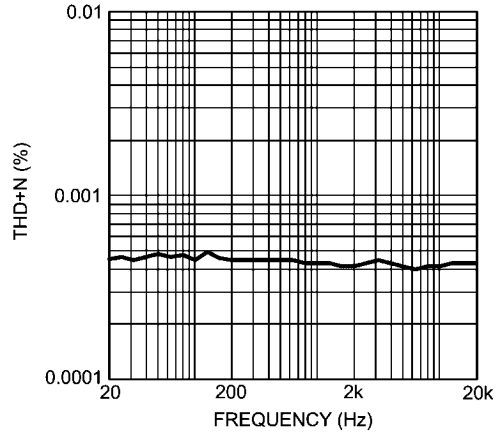

202132p6

THD vs Frequency
 $V_O = 3V_{RMS}, R_L = 100\Omega$

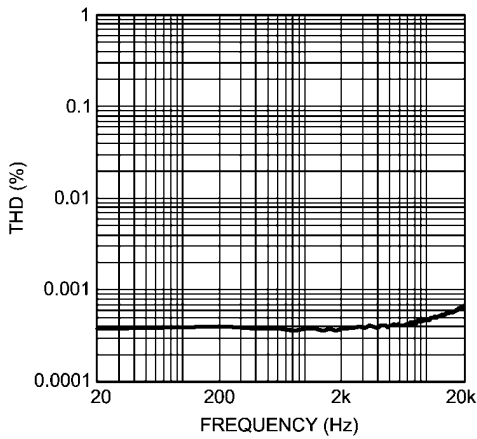

202132p7

THD vs Output Voltage
 $V_O = 3V_{RMS}, R_L = 600\Omega$

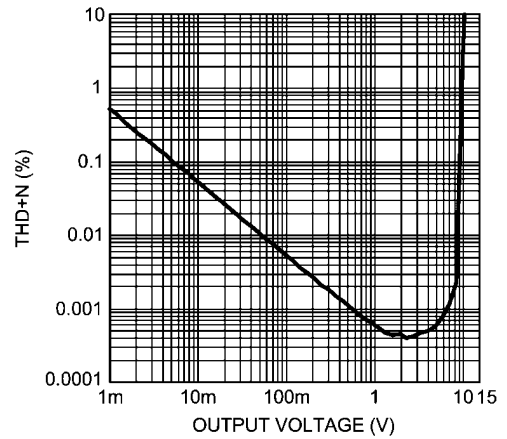

202132p8

THD vs RF

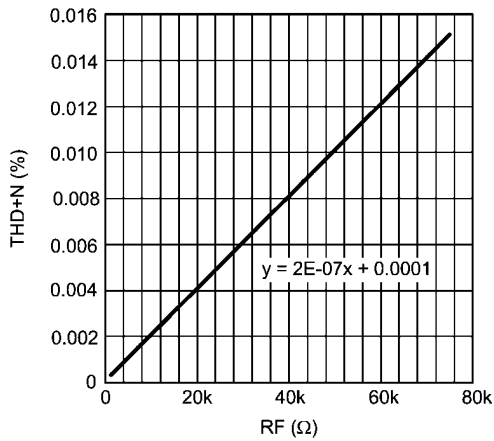

202132p9

Output Voltage vs Supply Voltage
 $A_V = 1, R_L = 600\Omega$

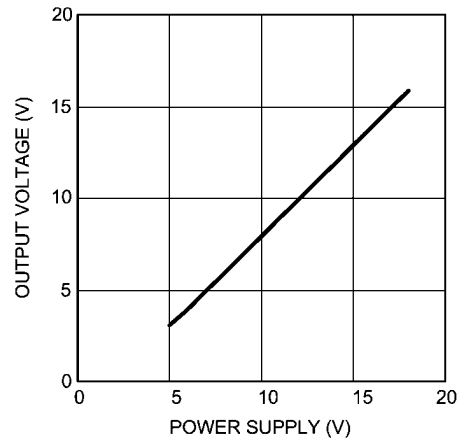

20213212

Output Voltage vs Supply Voltage
 $A_V = 1, R_L = \text{open}$

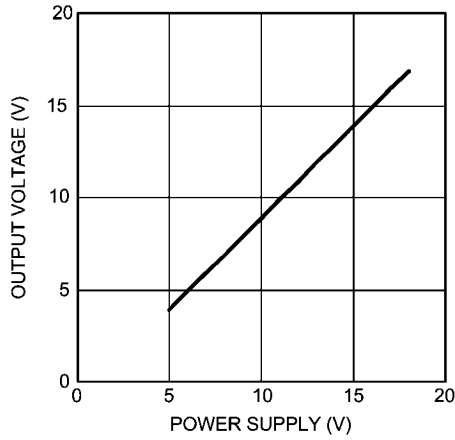

20213213

Supply Current (I_{CC}) vs Power Supply
 $R_L = \text{open}$

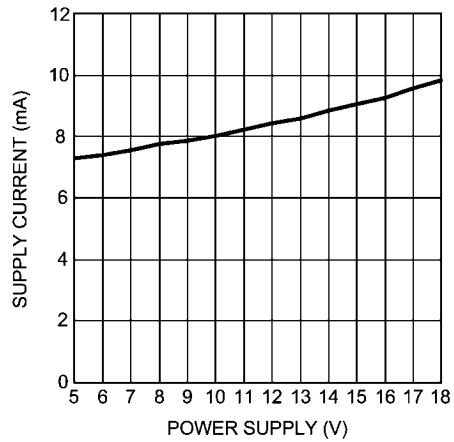

20213214

Supply Current (I_{EE}) vs Power Supply
 $R_L = \text{open}$

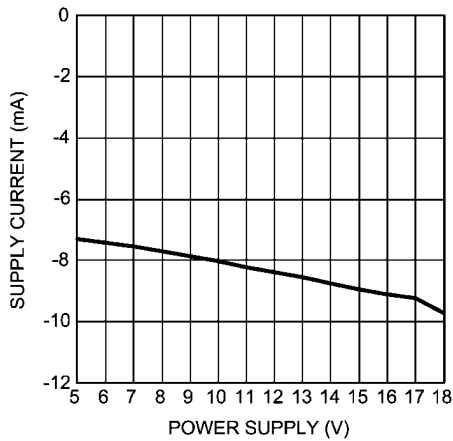

20213215

Gain vs Frequency
 $V_S = \pm 15V, G = -1$

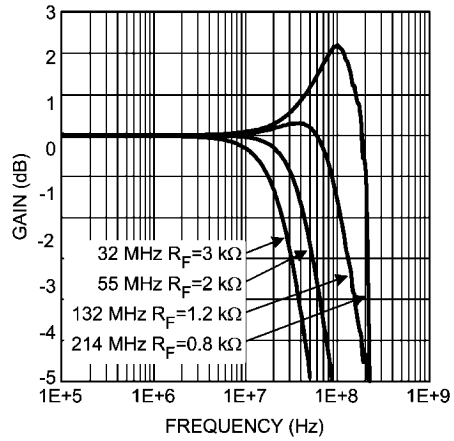

20213204

Gain vs Frequency
 $V_S = \pm 15V, G = -2$

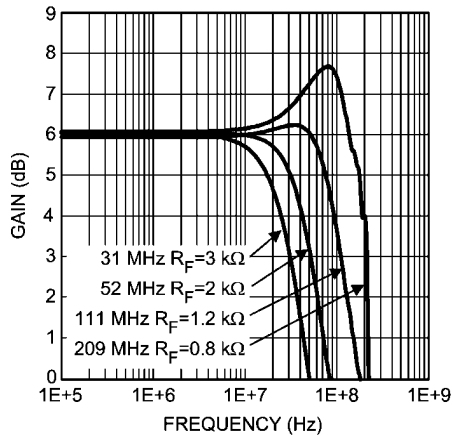

20213205

Gain vs Frequency
 $V_S = \pm 15V, G = -5$

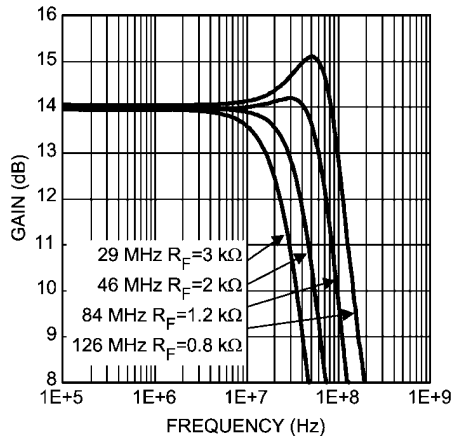

20213206

Gain vs Frequency
 $V_S = \pm 15V, G = -10$

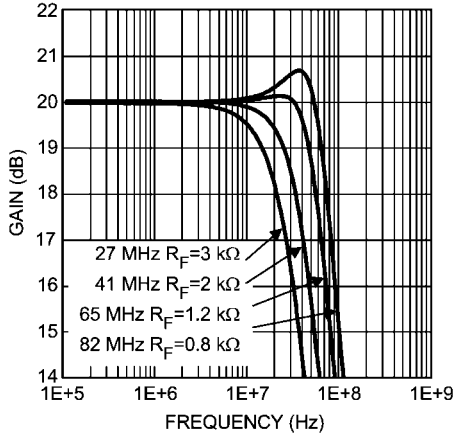

20213207

Gain vs Frequency
 $R_F = 800\Omega, V_S = \pm 15V$

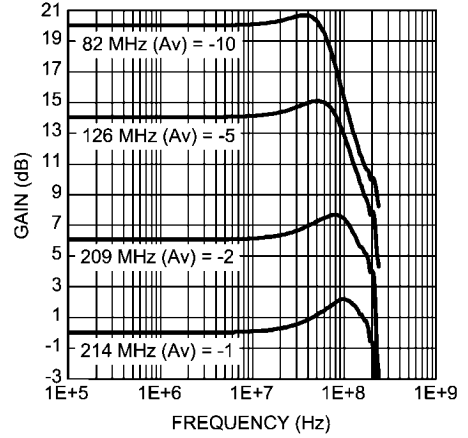

20213208

Gain vs Frequency
 $R_F = 1.2k\Omega, V_S = \pm 15V$

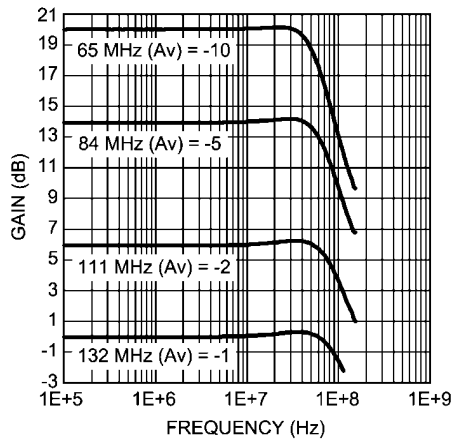

20213209

Gain vs Frequency
 $R_F = 2k\Omega, V_S = \pm 15V$

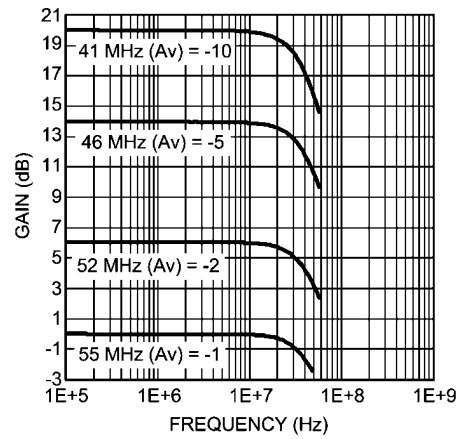

20213210

Gain vs Frequency
 $R_F = 3k\Omega, V_S = \pm 15V$

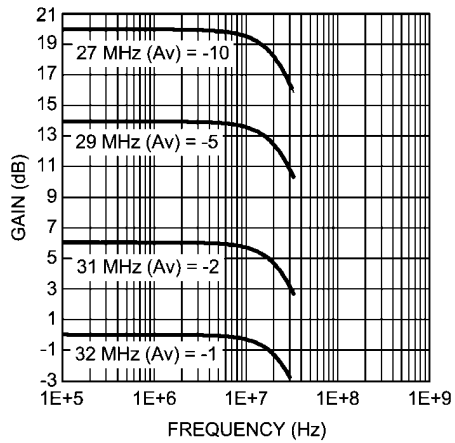

20213211

CMRR vs Frequency
 $V_S = \pm 15V$

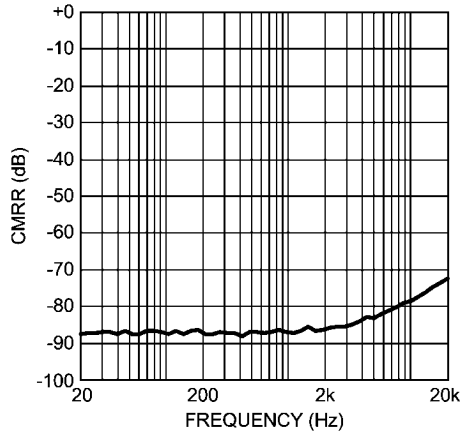

202132p0

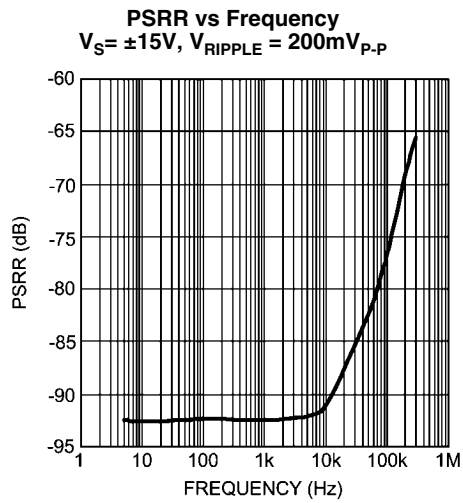

202132p3

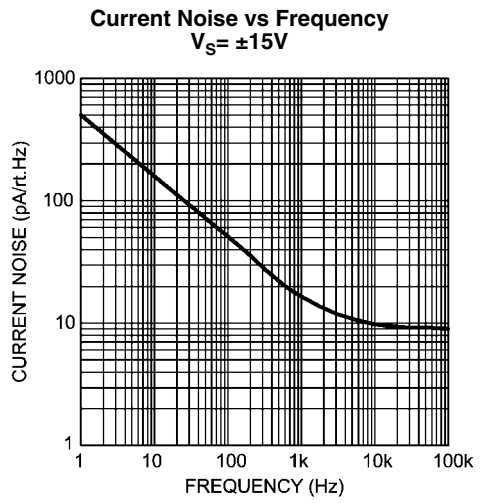

202132p1

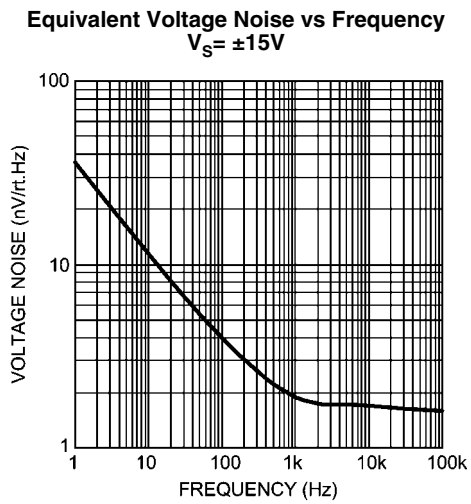

202132p2

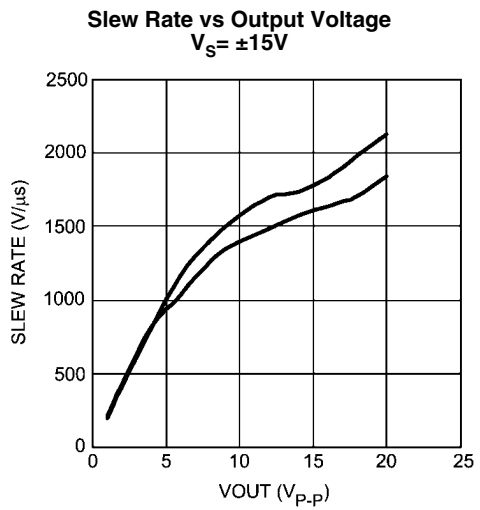

202132p4

Application Information

GENERAL AMPLIFIER FUNCTION

Voltage feedback amplifiers have a small-signal bandwidth that is a function of the closed-loop gain. Conversely, the LME49713 current feedback amplifier features a small-signal bandwidth that is relatively independent of the closed-loop gain. This is shown in Figure 1 where the LME49713's gain is -1 , -2 , -5 and -10 . Like all current feedback amplifiers, the LME49713's closed-loop bandwidth is a function of the feedback resistance value. Therefore, R_s must be varied to select the desired closed-loop gain.

POWER SUPPLY BYPASSING AND LAYOUT CONSIDERATIONS

Properly placed and correctly valued supply bypassing is essential for optimized high-speed amplifier operation. The supply bypassing must maintain a wideband, low-impedance capacitive connection between the amplifier's supply pin and ground. This helps preserve high speed signal and fast transient fidelity. The bypassing is easily accomplished using a parallel combination of a $10\mu\text{F}$ tantalum and a $0.1\mu\text{F}$ ceramic capacitors for each power supply pin. The bypass capacitors should be placed as close to the amplifier power supply pins as possible.

FEEDBACK RESISTOR SELECTION (R_f)

The value of the R_f is also a dominant factor in compensating the LME49713. For general applications, the LME49713 will maintain specified performance with an $1.2\text{k}\Omega$ feedback resistor. Although this value will provide good results for most applications, it may be advantageous to adjust this value slightly for best pulse response optimized for the desired bandwidth. In addition to reducing bandwidth, increasing the feedback resistor value also reduces overshoot in the time domain response.

SLEW RATE CONSIDERATIONS

A current feedback amplifier's slew rate characteristics are different than that of voltage feedback amplifiers. A voltage feedback amplifier's slew rate limiting or non-linear amplifier behavior is dominated by the finite availability of the first stage tail current charging the second stage voltage amplifier's compensation capacitor. Conversely, a current feedback amplifier's slew rate is not constant. Transient current at the inverting input determines slew rate for both inverting and non-inverting gains. The non-inverting configuration slew rate is also determined by input stage limitations. Accordingly, variations of slew rates occur for different circuit topologies.

DRIVING CAPACITIVE LOADS

The LME49713 can drive significantly higher capacitive loads than many current feedback amplifiers. Although the LME49713 can directly drive as much as 100pF without oscillating, the resulting response will be a function of the feedback resistor value.

CAPACITIVE FEEDBACK

It is quite common to place a small lead-compensation capacitor in parallel with a voltage feedback amplifier's feedback resistance, R_f . This compensation reduces the amplifier's peaking in the frequency domain and damps the transient response. Whereas this yields the expected results when used with voltage feedback amplifiers, this technique must not be used with current feedback amplifiers. The dynamic impedance of capacitors in the feedback loop reduces the amplifier's stability. Instead, reduced peaking in the frequency response and bandwidth limiting can be accomplished by adding an RC circuit to the amplifier's input.

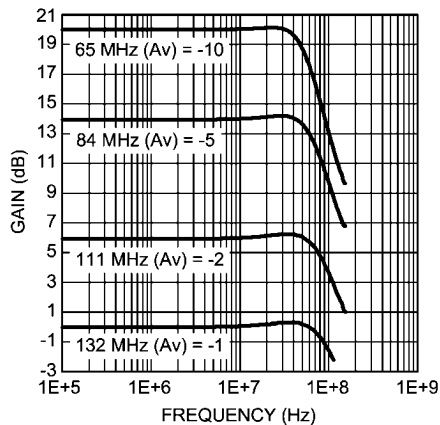

20213209

FIGURE 1. Bandwidth as a function of gain

Revision History

Rev	Date	Description
1.0	09/26/07	Initial release.
1.1	09/28/07	Added the Typical Performance curves.
1.2	10/03/07	Input Limit values.
1.3	10/29/07	Edited the Specification table, typical performance curve, and text edits.
1.4	01/29/08	Added more curves in the Typical Performance section.
1.5	07/24/08	Added the Metal Can package.
1.6	08/20/08	Text edits (updated some of the curves' titles).
1.7	08/22/08	Text edits.

Physical Dimensions inches (millimeters) unless otherwise noted

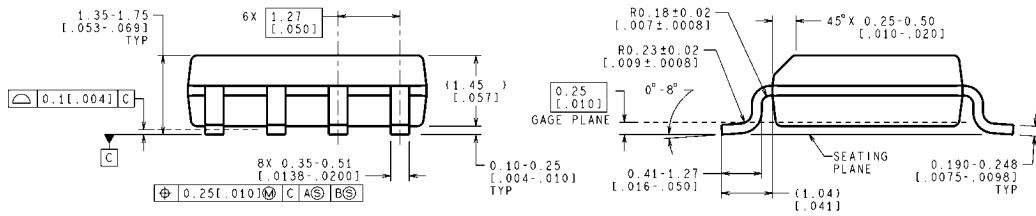
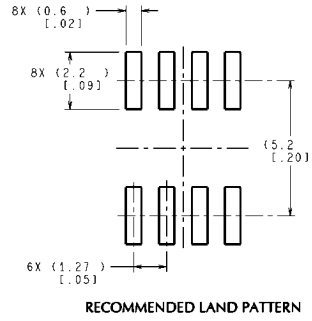
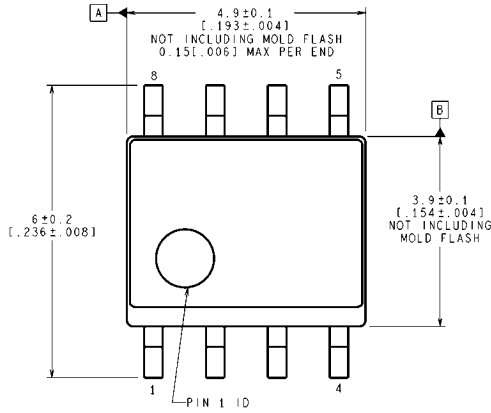

CONTROLLING DIMENSION IS MILLIMETER
VALUES IN [] ARE INCHES
DIMENSIONS IN () FOR REFERENCE ONLY

M08A (Rev L)

SOIC Package
Order Number LME49713MA
NS Package Number M08A

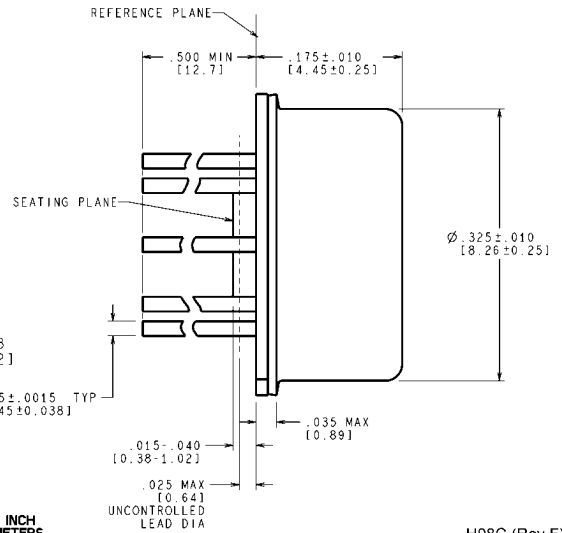
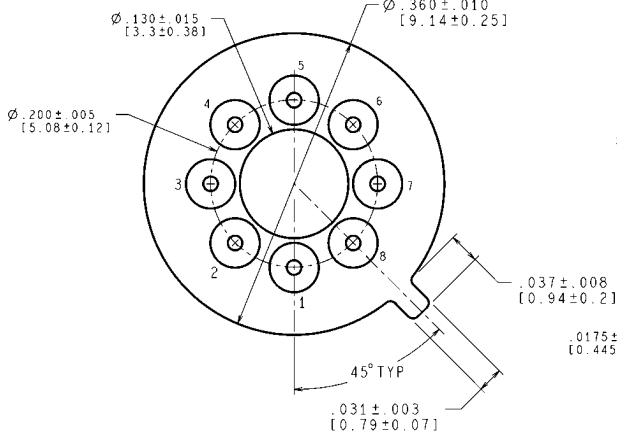

CONTROLLING DIMENSION IS INCH
VALUES IN [] ARE IN MILLIMETERS

H08C (Rev F)

Metal Can
Order Number LME49713HA
NS Package Number H08C

Notes

Notes

For more National Semiconductor product information and proven design tools, visit the following Web sites at:

Products		Design Support	
Amplifiers	www.national.com/amplifiers	WEBENCH	www.national.com/webench
Audio	www.national.com/audio	Analog University	www.national.com/AU
Clock Conditioners	www.national.com/timing	App Notes	www.national.com/appnotes
Data Converters	www.national.com/adc	Distributors	www.national.com/contacts
Displays	www.national.com/displays	Green Compliance	www.national.com/quality/green
Ethernet	www.national.com/ethernet	Packaging	www.national.com/packaging
Interface	www.national.com/interface	Quality and Reliability	www.national.com/quality
LVDS	www.national.com/lvds	Reference Designs	www.national.com/refdesigns
Power Management	www.national.com/power	Feedback	www.national.com/feedback
Switching Regulators	www.national.com/switchers		
LDOs	www.national.com/ldo		
LED Lighting	www.national.com/led		
PowerWise	www.national.com/powerwise		
Serial Digital Interface (SDI)	www.national.com/sdi		
Temperature Sensors	www.national.com/tempsensors		
Wireless (PLL/VCO)	www.national.com/wireless		

THE CONTENTS OF THIS DOCUMENT ARE PROVIDED IN CONNECTION WITH NATIONAL SEMICONDUCTOR CORPORATION ("NATIONAL") PRODUCTS. NATIONAL MAKES NO REPRESENTATIONS OR WARRANTIES WITH RESPECT TO THE ACCURACY OR COMPLETENESS OF THE CONTENTS OF THIS PUBLICATION AND RESERVES THE RIGHT TO MAKE CHANGES TO SPECIFICATIONS AND PRODUCT DESCRIPTIONS AT ANY TIME WITHOUT NOTICE. NO LICENSE, WHETHER EXPRESS, IMPLIED, ARISING BY ESTOPPEL OR OTHERWISE, TO ANY INTELLECTUAL PROPERTY RIGHTS IS GRANTED BY THIS DOCUMENT.

TESTING AND OTHER QUALITY CONTROLS ARE USED TO THE EXTENT NATIONAL DEEMS NECESSARY TO SUPPORT NATIONAL'S PRODUCT WARRANTY. EXCEPT WHERE MANDATED BY GOVERNMENT REQUIREMENTS, TESTING OF ALL PARAMETERS OF EACH PRODUCT IS NOT NECESSARILY PERFORMED. NATIONAL ASSUMES NO LIABILITY FOR APPLICATIONS ASSISTANCE OR BUYER PRODUCT DESIGN. BUYERS ARE RESPONSIBLE FOR THEIR PRODUCTS AND APPLICATIONS USING NATIONAL COMPONENTS. PRIOR TO USING OR DISTRIBUTING ANY PRODUCTS THAT INCLUDE NATIONAL COMPONENTS, BUYERS SHOULD PROVIDE ADEQUATE DESIGN, TESTING AND OPERATING SAFEGUARDS.

EXCEPT AS PROVIDED IN NATIONAL'S TERMS AND CONDITIONS OF SALE FOR SUCH PRODUCTS, NATIONAL ASSUMES NO LIABILITY WHATSOEVER, AND NATIONAL DISCLAIMS ANY EXPRESS OR IMPLIED WARRANTY RELATING TO THE SALE AND/OR USE OF NATIONAL PRODUCTS INCLUDING LIABILITY OR WARRANTIES RELATING TO FITNESS FOR A PARTICULAR PURPOSE, MERCHANTABILITY, OR INFRINGEMENT OF ANY PATENT, COPYRIGHT OR OTHER INTELLECTUAL PROPERTY RIGHT.

LIFE SUPPORT POLICY

NATIONAL'S PRODUCTS ARE NOT AUTHORIZED FOR USE AS CRITICAL COMPONENTS IN LIFE SUPPORT DEVICES OR SYSTEMS WITHOUT THE EXPRESS PRIOR WRITTEN APPROVAL OF THE CHIEF EXECUTIVE OFFICER AND GENERAL COUNSEL OF NATIONAL SEMICONDUCTOR CORPORATION. As used herein:

Life support devices or systems are devices which (a) are intended for surgical implant into the body, or (b) support or sustain life and whose failure to perform when properly used in accordance with instructions for use provided in the labeling can be reasonably expected to result in a significant injury to the user. A critical component is any component in a life support device or system whose failure to perform can be reasonably expected to cause the failure of the life support device or system or to affect its safety or effectiveness.

National Semiconductor and the National Semiconductor logo are registered trademarks of National Semiconductor Corporation. All other brand or product names may be trademarks or registered trademarks of their respective holders.

Copyright© 2008 National Semiconductor Corporation

For the most current product information visit us at www.national.com



National Semiconductor Americas Technical Support Center
 Email: support@nsc.com
 Tel: 1-800-272-9959

National Semiconductor Europe Technical Support Center
 Email: europe.support@nsc.com
 German Tel: +49 (0) 180 5010 771
 English Tel: +44 (0) 870 850 4288

National Semiconductor Asia Pacific Technical Support Center
 Email: ap.support@nsc.com

National Semiconductor Japan Technical Support Center
 Email: jpn.feedback@nsc.com